

**SAP Manufacturing Execution
How-To Guide**



How To Set Up and Use the SAP ME Visual Test and Repair Feature

Applicable Release: ME 6.0

Version 1.7

October 1, 2012

SAP ME How-To-Guide for Visual Test and Repair (VTR)

© Copyright 2012 SAP AG. All rights reserved.

No part of this publication may be reproduced or transmitted in any form or for any purpose without the express permission of SAP AG. The information contained herein may be changed without prior notice.

Some software products marketed by SAP AG and its distributors contain proprietary software components of other software vendors.

Microsoft, Windows, Outlook, and PowerPoint are registered trademarks of Microsoft Corporation.

IBM, DB2, DB2 Universal Database, OS/2, Parallel Sysplex, MVS/ESA, AIX, S/390, AS/400, OS/390, OS/400, iSeries, pSeries, xSeries, zSeries, z/OS, AFP, Intelligent Miner, WebSphere, Netfinity, Tivoli, Informix, i5/OS, POWER, POWER5, OpenPower and PowerPC are trademarks or registered trademarks of IBM Corporation.

Adobe, the Adobe logo, Acrobat, PostScript, and Reader are either trademarks or registered trademarks of Adobe Systems Incorporated in the United States and/or other countries.

Oracle is a registered trademark of Oracle Corporation.

UNIX, X/Open, OSF/1, and Motif are registered trademarks of the Open Group.

Citrix, ICA, Program Neighborhood, MetaFrame, WinFrame, VideoFrame, and MultiWin are trademarks or registered trademarks of Citrix Systems, Inc.

HTML, XML, XHTML and W3C are trademarks or registered trademarks of W3C®, World Wide Web Consortium, Massachusetts Institute of Technology.

Java is a registered trademark of Sun Microsystems, Inc.

JavaScript is a registered trademark of Sun Microsystems, Inc., used under license for technology invented and implemented by Netscape.

MaxDB is a trademark of MySQL AB, Sweden.

SAP, R/3, mySAP, mySAP.com, xApps, xApp, SAP NetWeaver, and other SAP products and services mentioned herein as well as their respective logos are trademarks or registered trademarks of SAP AG in Germany and in several other countries all over the world. All other product and service names mentioned are the trademarks of their respective companies. Data contained in this document serves informational purposes only. National product specifications may vary.

These materials are subject to change without notice.

These materials are provided by SAP AG and its affiliated companies ("SAP Group") for informational purposes only, without representation or warranty of any kind, and SAP Group shall not be liable for errors or omissions with respect to the materials. The only warranties for SAP Group products and services are those that are set forth in the express warranty statements accompanying such products and services, if any. Nothing herein should be construed as constituting an additional warranty.

These materials are provided "as is" without a warranty of any kind, either express or implied, including but not limited to, the implied warranties of merchantability, fitness for a particular purpose, or non-infringement.

SAP shall not be liable for damages of any kind including without limitation direct, special, indirect, or consequential damages that may result from the use of these materials.

SAP does not warrant the accuracy or completeness of the information, text, graphics, links or other items contained within these materials. SAP has no control over the information that you may access through the use of hot links contained in these materials and does not endorse your use of third party web pages nor provide any warranty whatsoever relating to third party web pages.

SAP ME "How-to" Guides are intended to simplify the product implementation. While specific product features and procedures typically are explained in a practical business context, it is not implied that those features and procedures are the only approach in solving a specific business problem using SAP ME. Should you wish to receive additional information, clarification or support, please refer to SAP Consulting.

SAP ME How-To-Guide for Visual Test and Repair (VTR)

Document History

Document Version	Description	Author
1.0	Initial version	Chet Moutrie
1.1	Updated to new SAP ME How-To-Guide template	Chet Moutrie
1.2	Updated to reflect acquisition of Right Hemisphere by SAP	Chet Moutrie
1.3	Updated to reflect new software and ECAD license delivery procedures	Chet Moutrie
1.4	Added screenshots	Chet Moutrie
1.5	Added Best Practice information (red text) in POD Maintenance section	Chet Moutrie
1.6	Added Best Practice information (red text) in sections 3.1.5 and 3.8.4	Chet Moutrie
1.7	Added Best Practice information (red text) in section 3.1.5 regarding reducing ECAD model load time	Chet Moutrie

Table of Contents

1	Introduction	1
1.1	Purpose	1
1.2	Scope.....	1
1.3	Glossary.....	1
2	Visual Test and Repair Overview.....	1
2.1	Description and Applicability	1
2.2	Business Purposes / Functions.....	2
2.3	High-Level Process Flows	2
2.4	High Level Data Model	3
2.5	Screenshot	3
3	VTR Functions	4
3.1	Display Model	4
3.1.1	Description and Applicability	4
3.1.2	Process Flow.....	5
3.1.3	Data Model.....	5
3.1.4	Function Specific Setup	5
3.1.5	Best Practices	6
3.2	View ECAD Model	6
3.2.1	Description and Applicability	6
3.2.2	Purpose / Effects	7
3.3	View 3D Model.....	10
3.3.1	Description and Applicability	10
3.3.2	Purpose / Effects	11
3.4	Select NC Code	15
3.4.1	Description and Applicability	15
3.5	Select Model Element / Object	15
3.5.1	Description and Applicability	15
3.5.2	Purpose / Effects	16
3.5.3	Process Flow.....	17
3.5.4	Data Model.....	17

SAP ME How-To-Guide for Visual Test and Repair (VTR)

3.5.5	Function Specific Setup	17
3.6	Log NC Code	18
3.6.1	Description and Applicability	18
3.7	Log a Test / Inspection Failure	18
3.7.1	Description and Applicability	18
3.8	View Element or Object for Logged NC Code	18
3.8.1	Description and Applicability	18
3.8.2	Process Flow.....	19
3.8.3	Data Model.....	19
3.9	Perform Analysis and Log Defect	20
3.9.1	Description and Applicability	20
3.9.2	Purpose / Effects	20
3.10	Perform and Log a Repair	20
3.10.1	Description and Applicability	20
3.10.2	Purpose / Effects	20
4	Integration	21
4.1	Integration with Nonconformance	21
5	VTR Setup.....	21
5.1	External Configuration	21
5.1.1	Installation	21
5.1.2	External Program Setup	22
5.1.3	Client Device	24
5.2	Maintenance Activities	24
5.2.1	System Rules	24
5.2.2	System Setup Properties.....	25
5.2.3	Best Practice.....	26
5.2.4	Product Configuration.....	26
5.2.5	System Configuration.....	26
5.2.6	Other Maintenance Activities	29
6	Usage Scenario Examples.....	29
6.1	ECAD Test Failure, Analysis and Repair Scenario.....	29
6.1.1	Purpose / Goal	29

SAP ME How-To-Guide for Visual Test and Repair (VTR)

6.1.2	Scenario Specific Settings.....	30
6.1.3	Scenario Steps.....	30
6.1.4	Scenario Flow	31
6.1.5	Scenario Best Practices	31
7	Links to Additional Information	32
8	Other Reference Material	32
9	Overview of Changes	32
9.1	PCA Dashboard Replaced by Visual Test and Repair	32

1 Introduction

1.1 Purpose

The ME Help How-To-Guide for the Visual Test and Repair (VTR) feature is intended to provide sufficient information to enable the feature to be easily configured and readily utilized to meet business needs, making use of available best practices.

1.2 Scope

This Help information covers all aspects of the VTR feature and its integration with the Nonconformance Management feature. It does not cover the Nonconformance Management feature itself.

1.3 Glossary

Defect	A specific condition of a material, or a material component or feature, which caused or contributed to a Failure
Failure	An event caused by a material, or a material component or feature, not passing a test or an inspection.
PCA	Printed Circuit Assembly
PCB	Printed Circuit Board
Repair	Action taken to address, or disposition, an NC Code logged for a Defect or a Failure.
VTR	Visual Test and Repair – SAP ME feature which facilitates the logging of NC Codes for Failures, Defects and Repairs.

2 Visual Test and Repair Overview

This overview provides a high level description of the Visual Test and Repair (VTR) feature.

2.1 Description and Applicability

VTR is used to record the NC Codes resulting from the testing / inspection, analysis and repair of PCA boards or other materials. VTR enables you to view and interact with a graphical model of the board, or of other material being manufactured, to ensure the correctness of the data being recorded in the Nonconformance Management feature.

It enables electronics manufacturers, in particular printed circuit board assemblers, to log defects against printed circuit boards and their components. Discrete manufacturers can use it to log defects against assemblies and their component parts.

SAP ME How-To-Guide for Visual Test and Repair (VTR)

VTR integrates the Model Viewer with the following Nonconformance Management plug-ins:

- NC Data Entry
- NC Selection
- NC Tree

In the VTR POD, when the user selects an SFC number the Model Viewer displays the graphical model specified for the associated Material. Selecting an element in the Model Viewer populates fields in the NC Data Entry plug-in. Specifying values in the NC Data Entry plug-in fields highlights the corresponding element in the Model Viewer. Similarly, selecting a logged NC Code in the NC Tree plug-in highlights, centers and zooms the corresponding element in the Model Viewer.

2.2 Business Purposes / Functions

The primary purpose of the VTR feature is to facilitate the logging of NC Codes with the correct data. It does this by enabling the user to select a model element in the Model Viewer to automatically populate specific NC Data Entry plug-in fields. The Model Viewer provides numerous graphical display control capabilities to make it easy for the user to manipulate the graphical image and to select the appropriate model element.

Once a Failure NC Code has been logged and is displayed in the NC Tree, VTR can be used to facilitate the analysis of the Failure and the logging of one or more Defect NC Codes. Similarly, for each Defect NC Code that has been logged and is displayed in the NC Tree, VTR facilitates the logging of a Repair NC Code.

VTR can also be used to simply review, graphically, which model element is associated with each logged NC Code for an SFC number.

2.3 High-Level Process Flows

This figure illustrates the primary flow of user actions when utilizing VTR to support the testing / inspection, analysis and repair of a PCA Board or a product assembly.

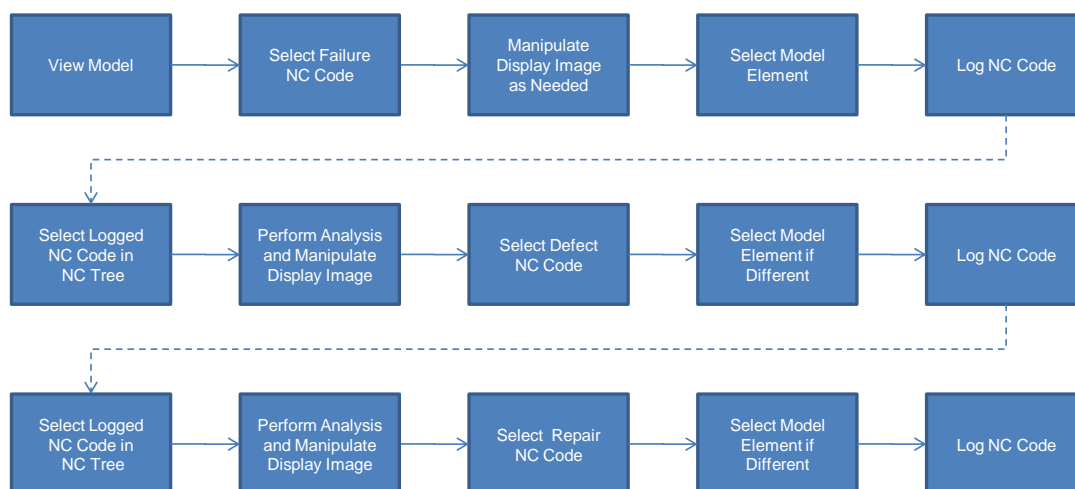

SAP ME How-To-Guide for Visual Test and Repair (VTR)

2.4 High Level Data Model

The following figure shows the relationship between some of the VTR functions and ME database tables.

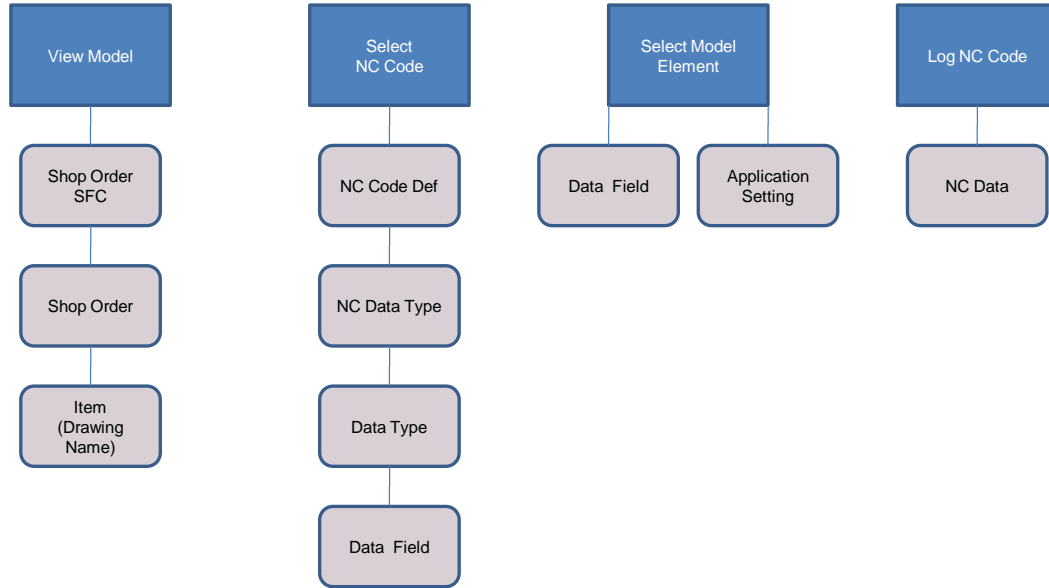

2.5 Screenshot

The following is a screenshot showing a portion of a VTR POD in SAP ME.

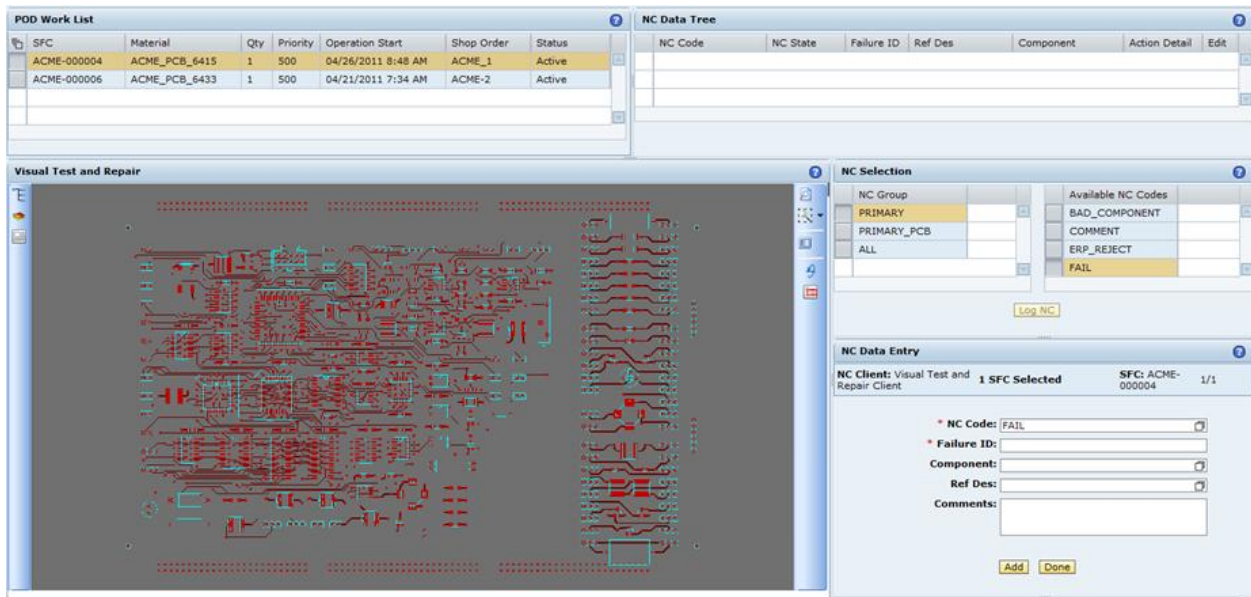

3 VTR Functions

3.1 Display Model

3.1.1 Description and Applicability

The VTR Model Viewer is a POD plug-in that displays a graphical model in the Model Viewer Viewport. The graphical model is extracted from an input file and converted for viewing. The input file that is used is determined by the file name in the Drawing Name field of the Material that is associated to the SFC number currently selected in the POD. The input file can contain either an ECAD model or a 3D solid model.

The following table identifies the ECAD file formats that are supported:

File Format	Type	Extension	Version/Notes
A3P	Text	A3P	Requires <i>ECAD Add-in Module</i> license
GenCAD	Text	CAD	Requires <i>ECAD Add-in Module</i> license
GenCAM (IPC-2511)	Text	GCM	Requires <i>ECAD Add-in Module</i> license
ODB++	Text	ODB	Requires <i>ECAD Add-in Module</i> license
Offspring (IPC-2581)	Text	CVG	Requires <i>ECAD Add-in Module</i> license

The A3P and GenCAM file formats can also contain schematic information which can be displayed by the Model Viewer in the form of 2D schematic sheets.

When any of the following actions occurs, the Model Viewer will load the input file associated to the material for the currently selected SFC number(s):

- The user selects a button that loads the Model Viewer plug-in into a panel in the POD and an SFC number is already selected, that has a material with an associated model
- The user selects a button that loads the Model Viewer plug-in into a panel in the POD and multiple SFC numbers are already selected, which all have the same material and version and the material has an associated model
- The user selects a single SFC number, that has a material with an associated model, and the Model Viewer plug-in is already loaded.
- The user selects multiple SFC numbers, which all have the same material and version and the material has an associated model, and the Model Viewer plug-in is already loaded.

If multiple SFC numbers are selected, but they do not all have the same material and version, then the Model Viewer will not load an input file.

The input file is located by creating a URL, by appending the text string from the Drawing Name field of the Material to the text string from the System Rule - VTR Model Location. In this example, the MODELS folder must be a shared folder accessible by all VTR users.

VTR Model Location	\\ATLN00XXXXA\MODELS\
Drawing Name	GRDemo.gcm
URL	\\ATLN00XXXXA\MODELS\GRDemo.gcm

SAP ME How-To-Guide for Visual Test and Repair (VTR)

3.1.2 Process Flow

This figure illustrates the primary flow of user and system actions to display the ECAD model. User Action is in blue and system action is in light blue.

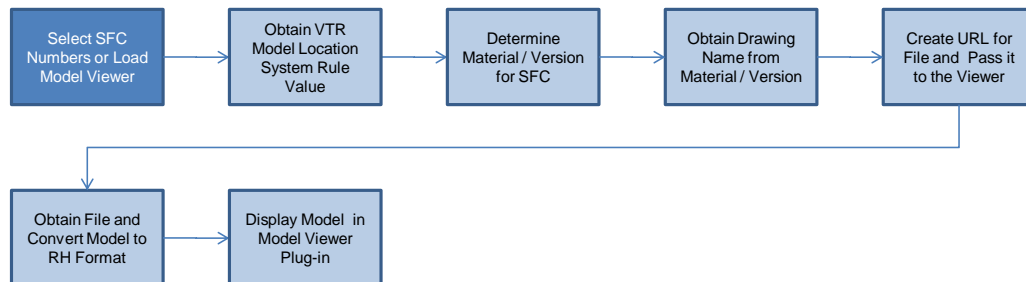

3.1.3 Data Model

The following figure shows the relationship between some of the VTR functions and ME database tables.

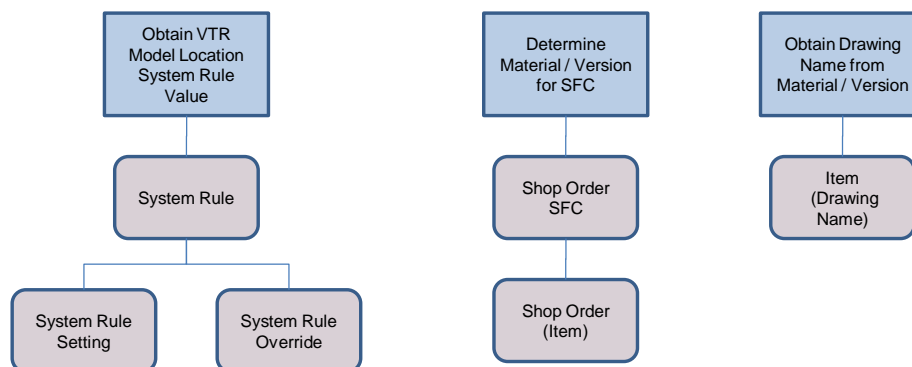

3.1.4 Function Specific Setup

For setting up this function, see [System Rules](#) and [Material Maintenance](#). If the error message “Local File Not Found” is displayed when attempting to load a model, there is likely a problem with:

- VTR Model Location system rule value
- Material Drawing Name value
- Access to the network shared folder where model files are stored

Common mistakes are:

- Omitting the “\” at the end of the VTR Model Location text string
- Not properly sharing the folder where the model files are stored (it must be shared with everyone who will be viewing any of the model files)

SAP ME How-To-Guide for Visual Test and Repair (VTR)

The model can be displayed using any one of the following display rendering technologies:

- Software
- OpenGL
- DirectX

To choose the display technology, click the right mouse button in the Model Viewer viewport; select the Preferences entry in the context menu; select the Display Renderer entry in the additional context menu; select the display technology entry in the rightmost context menu.

3.1.5 Best Practices

Choose the display technology that works best on your client device. Experience to-date indicates that DirectX is often the best choice.

Configure the Slide-in Menus in the Model Viewer to always be displayed. Having them slide in and out sometimes causes problems with the viewer.

To reduce model load time, an ECAD model can be saved as a .rh file, which can then be used instead of the native ECAD file. Use the Export option, in the viewport context menu, available by right clicking the mouse while the cursor is in an empty space in the displayed model.

3.2 View ECAD Model

3.2.1 Description and Applicability

The ECAD input file contains a PCB Layout model. This is a 2D model with layering. It may also include a schematic model. The following screenshots show a portion of a schematic model.

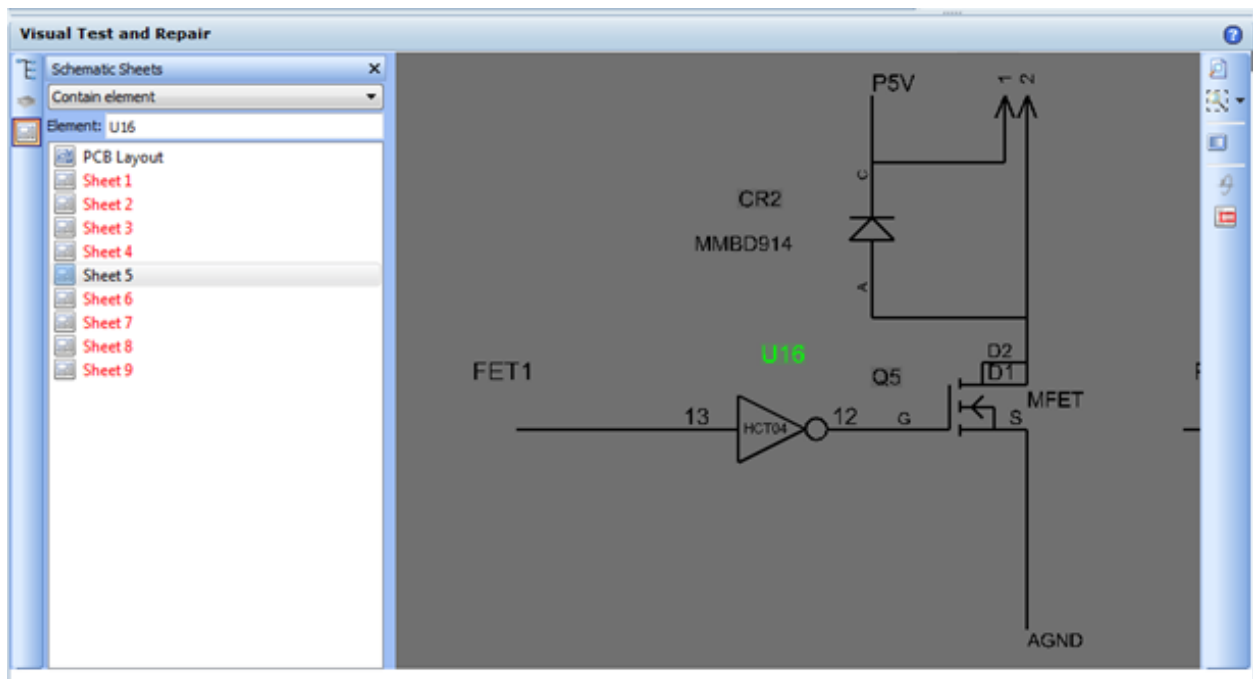

The Model Viewer provides display control capabilities to enable the user to manipulate the displayed image to achieve the needed view of the model. It also provides the capability to filter the contents of the model and to display only those model elements that pass the filters.

3.2.2 Purpose / Effects

3.2.2.1 Manipulate ECAD PCB Layout View

The Model Viewer provides several ways to manipulate the PCB Layout image displayed in the viewport. These include:

- Pan the image in any direction
- Zoom the image around the starting cursor position
- Switch to Best Fit view
- Center and zoom specified area
- Center and zoom an already selected element
- Center and zoom all visible elements
- Center and zoom an element

The following screenshot shows a portion of a PCB Layout.

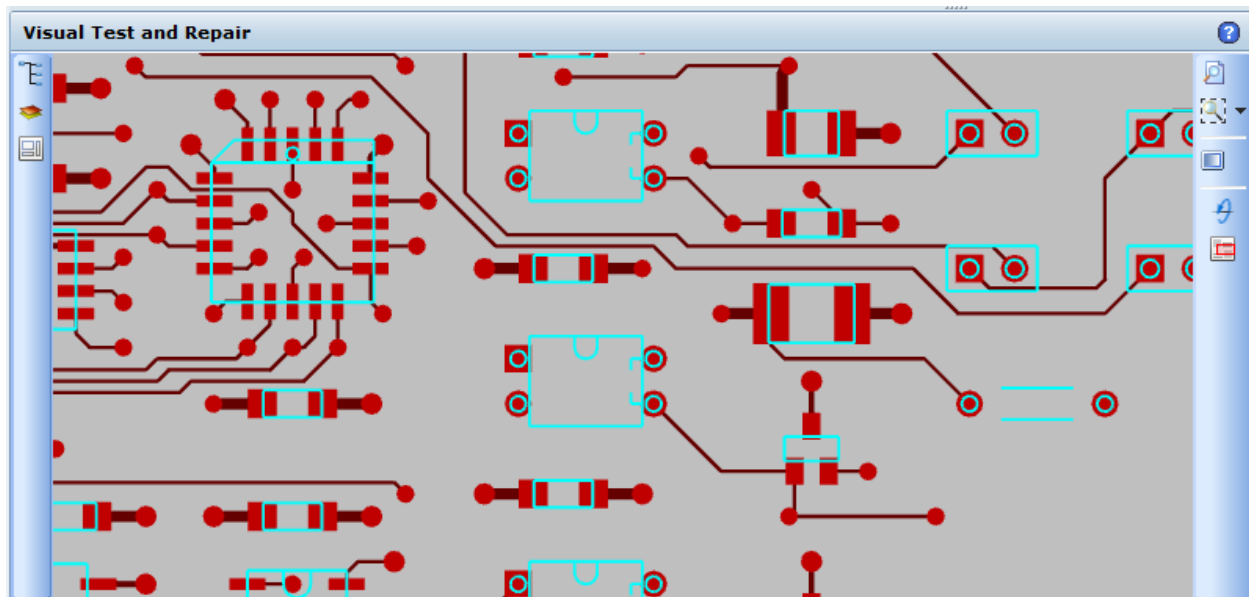

3.2.2.1.1 Pan

To pan the image, depress the left mouse button (or the left and right mouse buttons) and drag the cursor in any direction and release the mouse button(s). For small incremental horizontal movements, hold down the Left or Right Arrow key.

3.2.2.1.2 Zoom

To zoom the image, position the cursor at the point about which to zoom; depress the right mouse button and drag the cursor vertically (up to zoom in and down to zoom out).

3.2.2.1.3 Best Fit

To switch to the Best Fit view, select the Best Fit icon on the right side toolbar (if not displayed, select the drop down control on the Zoom Window icon).

3.2.2.1.4 Zoom Window

To center and zoom a specified area, select the Zoom Window icon on the right side toolbar; position the cursor at a corner of the area to be zoomed; depress the left mouse button and drag the cursor to the opposite corner of the area to be zoomed; release the mouse button. If the Zoom Window icon is not displayed, select the drop down control on the Best Fit icon. If the Zoom Window icon is already displayed, selecting it will toggle it on / off.

3.2.2.1.5 Zoom Selected Element

To center and zoom the already selected model element, position the cursor in an empty area in the image; click the right mouse button; use the left mouse button to select the Zoom to Active Object entry in the context menu.

3.2.2.1.6 Zoom Visible

To center and zoom all visible model elements (best fit on visible elements), position the cursor in an empty area in the image; click the right mouse button; use the left mouse button to select the Zoom Visible entry in the context menu.

3.2.2.1.7 Center and Zoom Element

To center and zoom an element, double click on the element in the viewport or double click on the element in the Elements List.

3.2.2.2 Filter ECAD PCB Layout View

The Model Viewer provides several ways to filter the contents of the PCB Layout image displayed in the viewport. These include:

- Switch ECAD view modes
- Layer control
- Flip the board
- Select / unselect element checkbox

3.2.2.2.1 Switch ECAD View Modes

To switch to the Schematic View mode, select the Schematic Sheets icon on the left hand toolbar; double click on a schematic sheet entry. This will display the selected schematic sheet in the viewport with the label for the currently selected component centered and zoomed. A schematic sheets entry displayed in black contains the currently selected model component. A schematic sheets entry displayed in red does not contain the currently selected model component.

3.2.2.2.2 Layer Control

To filter the contents of the model image by layers, select the Layers icon on the left hand toolbar; select a checkbox to turn on the display of the contents of that layer; unselect a checkbox to turn off the display of the contents of that layer.

3.2.2.2.3 Flip Board

Flipping the board automatically filters the contents of the model image by turning off the display of the layers currently displayed and turning on only the layers associated with the other side of the board. It also rotates the viewpoint 180 degrees about a horizontal axis along the length of the board and halfway up the height of the board. To flip the board, select the Flip Board icon. This will flip the board and toggle the state of the icon. When the icon is on, it indicates that the bottom of the board is being displayed. When the icon is off, it indicates that the top of the board is being displayed.

3.2.2.3 Manipulate ECAD Schematic View

The Model Viewer provides several ways to manipulate the Schematic image displayed in the viewport. These include:

- Pan the image in any direction
- Zoom the image around the starting cursor position
- Switch to Best Fit view
- Center and zoom specified area
- Center and zoom an already selected component label
- Center and zoom all visible
- Center and zoom a component label

3.2.2.3.1 Pan

To pan the image, depress the left mouse button (or the left and right mouse buttons) and drag the cursor in any direction and release the mouse button(s).

3.2.2.3.2 Zoom

To zoom the image, position the cursor at the point about which to zoom; depress the right mouse button and drag the cursor vertically (up to zoom in and down to zoom out).

3.2.2.3.3 Best Fit

To switch to the Best Fit view, select the Best Fit icon on the right side toolbar (if not displayed, select the drop down control on the Zoom Window icon).

3.2.2.3.4 Zoom Window

To center and zoom a specified area, select the Zoom Window icon on the right side toolbar; position the cursor at a corner of the area to be zoomed; depress the left mouse button and drag the cursor to the opposite corner of the area to be zoomed; release the mouse button. If the Zoom Window icon is not displayed, select the drop down control on the Best Fit icon. If the Zoom Window icon is already displayed, selecting it will toggle it on / off.

3.2.2.3.5 Zoom Selected Component Label

To center and zoom the already selected component label, position the cursor in an empty area in the image; click the right mouse button; use the left mouse button to select the Zoom to Active Object entry in the context menu.

3.2.2.3.6 Zoom Visible

To center and zoom all visible schematic elements (best fit on visible elements), position the cursor in an empty area in the image; click the right mouse button; use the left mouse button to select the Zoom Visible entry in the context menu.

3.2.2.3.7 Center and Zoom Component Label

To center and zoom a component label, double click on the component label in the viewport or double click on the component in the Elements List.

3.2.2.4 Filter ECAD Schematic View

The Model Viewer provides several ways to filter the contents of the schematic sheet image displayed in the viewport. These include:

- Switch ECAD view modes
- Switch schematic sheets

3.2.2.4.1 Switch ECAD View Modes

To switch to the PCB Layout View mode, select the Schematic Sheets icon on the left hand toolbar; double click on the PCB Layout entry. This will display the PCB Layout view with the selected component centered and zoomed.

3.2.2.4.2 Switch Schematic Sheets

To display a different schematic sheet, select the Schematic Sheets icon on the left hand toolbar; double click on the schematic sheet entry. This will display the selected schematic sheet in the viewport with the label for the currently selected component centered and zoomed. A schematic sheets entry displayed in black contains the currently selected model component. A schematic sheets entry displayed in red does not contain the currently selected model component.

3.3 View 3D Model

3.3.1 Description and Applicability

For 3D models, the input file must be in the Model Viewer proprietary format with an extension of RH. 3D models in many other formats can be converted to the RH format by using either of the following SAP products: Visual Enterprise Author or Visual Enterprise Generator.

SAP ME How-To-Guide for Visual Test and Repair (VTR)

The following screenshot shows a simple 3D model.

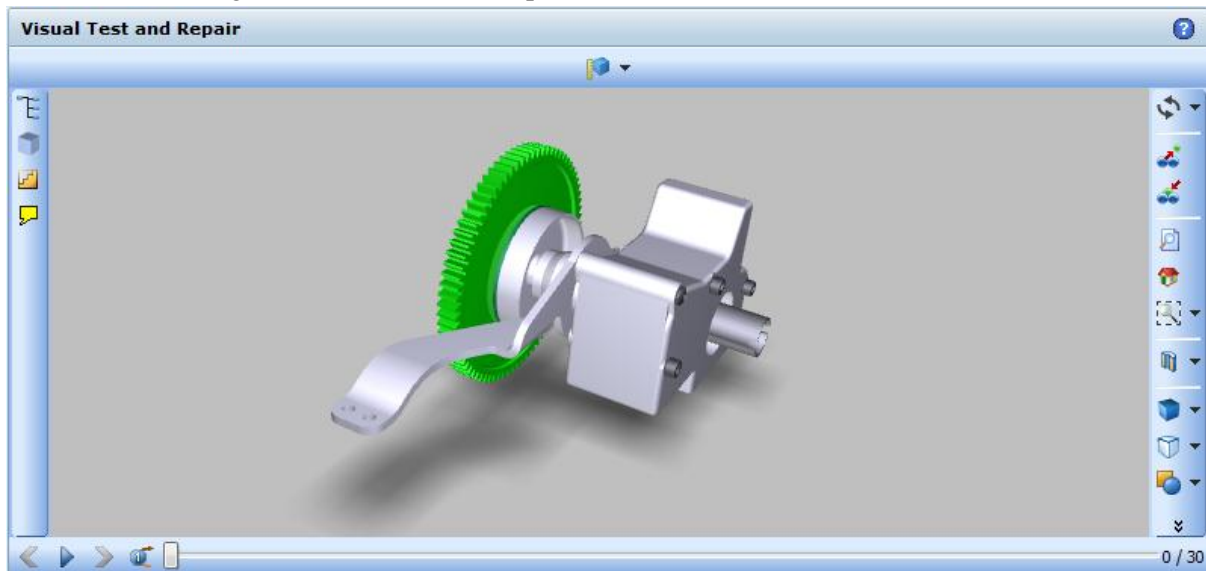

The Model Viewer provides display control capabilities to enable the user to manipulate the displayed image to achieve the needed view of the model. It also provides the capability to filter the contents of the model and to display only those model elements that pass the filters.

3.3.2 Purpose / Effects

3.3.2.1 Manipulate 3D Scene

The Model Viewer provides many ways to manipulate the 3D scene displayed in the viewport. These include:

- Rotate
- Auto Rotate
- Turn
- Pan
- Zoom
- Walkthrough the scene and look around
- Switch to Home view
- Switch to Best Fit view
- Center and zoom specified area
- Center and zoom an already selected object
- Center and zoom all visible objects
- Center and zoom all objects
- Center and zoom an object
- Other

3.3.2.1.1 Rotate

To rotate the camera in a plane parallel to the plane of the viewport, depress the Shift key and the left mouse button. To rotate the camera clockwise, drag the cursor to the left and to rotate counterclockwise, drag the cursor to the right.

To rotate the camera in a vertical plane perpendicular to the plane of the viewport and about an axis through the center of the viewport, depress the left mouse button. To rotate the camera up, drag the cursor up and to rotate the camera down, drag the cursor down.

To rotate the camera in a horizontal plane perpendicular to the plane of the viewport and about an axis through the center of the viewport, depress the left mouse button. To rotate the camera to the right, drag the cursor to the right and to rotate the camera to the left, drag the cursor to the left.

By dragging the cursor horizontally and vertically at the same time, the camera will be rotated in a plane perpendicular to the plane of the viewport and oriented along the direction of motion of the cursor. This is effectively a combination of the above two rotations.

You can obtain different rotation results by means of panning, scaling, and zooming. This way you can view the scene from all possible positions and at different levels of detail to obtain the display you require.

3.3.2.1.2 Auto Rotate

To continuously rotate the model, perform a rotation; click the right mouse button in the viewport; select the Display entry in the context menu; select the Auto Rotate entry in the additional context menu. The Model Viewer will continue to perform that rotation until you click the left or right mouse button in the viewport. Auto rotation will continue to occur for each rotation until you unselect the Auto Rotate entry in the context menu.

3.3.2.1.3 Turn

To rotate the camera only about a horizontal or vertical axis, select the Turn entry in the top most drop-down on the right hand toolbar; depress the left mouse button; drag the cursor horizontally or vertically; release the mouse button.

3.3.2.1.4 Pan

To pan the scene, depress the left and right mouse buttons and drag the scene in any direction and release the mouse buttons. Or select the Pan entry in the top most drop-down on the right hand toolbar; depress the left mouse button; drag the scene in any direction; release the mouse button.

3.3.2.1.5 Zoom

To zoom the scene, position the cursor at the point about which to zoom; depress the right mouse button and drag the cursor vertically (up to zoom in and down to zoom out).

3.3.2.1.6 Home

To switch to the Home view, select the Home icon on the right side toolbar. The Home view is the view defined as the starting view in the model.

3.3.2.1.7 Zoom Window

To center and zoom a specified area, select the Zoom Window icon on the right side toolbar; position the cursor at a corner of the area to be zoomed; depress the left mouse button and drag the cursor to the opposite corner of the area to be zoomed; release the mouse button. If the Zoom Window icon is not displayed, select the drop down control on the Best Fit icon. If the Zoom Window icon is already displayed, selecting it will toggle it on / off.

3.3.2.1.8 Zoom Selected Object

To center and zoom the already selected object, position the cursor in an empty area in the image; click the right mouse button; use the left mouse button to select the Zoom to Active Object entry in the context menu.

3.3.2.1.9 Zoom Visible

To center and zoom all visible objects (best fit on visible objects), position the cursor in an empty area in the image; click the right mouse button; use the left mouse button to select the Zoom Visible entry in the context menu.

3.3.2.1.10 Zoom All

To center and zoom all objects (best fit on all objects), position the cursor in an empty area in the image; click the right mouse button; use the left mouse button to select the Zoom All entry in the context menu.

3.3.2.1.11 Center and Zoom Object

To center and zoom an object, double click on the object in the viewport or double click on the object in the 3D Objects List.

3.3.2.1.12 Other

The Model Viewer provides many additional capabilities for manipulating the 3D Scene. Most of these capabilities are not directly applicable to the use of the Model Viewer in VTR. For information on these capabilities, see *Working with the Viewer* in SAP ME Help.

3.3.2.2 Manipulate 3D Model

The Model Viewer provides many ways to manipulate the 3D model displayed in the viewport. These include:

- Pull Apart
- Re-assemble
- Cross Section
- Model Render Mode
- Projection
- X-ray

3.3.2.2.1 Pull Apart

To move one or more objects from their original position, select the Pull Apart icon on the right hand toolbar, then select the object(s) and drag the object(s) to a new position. Pull apart is useful for providing access to interior objects (in an assembly) that are otherwise not visible for selection.

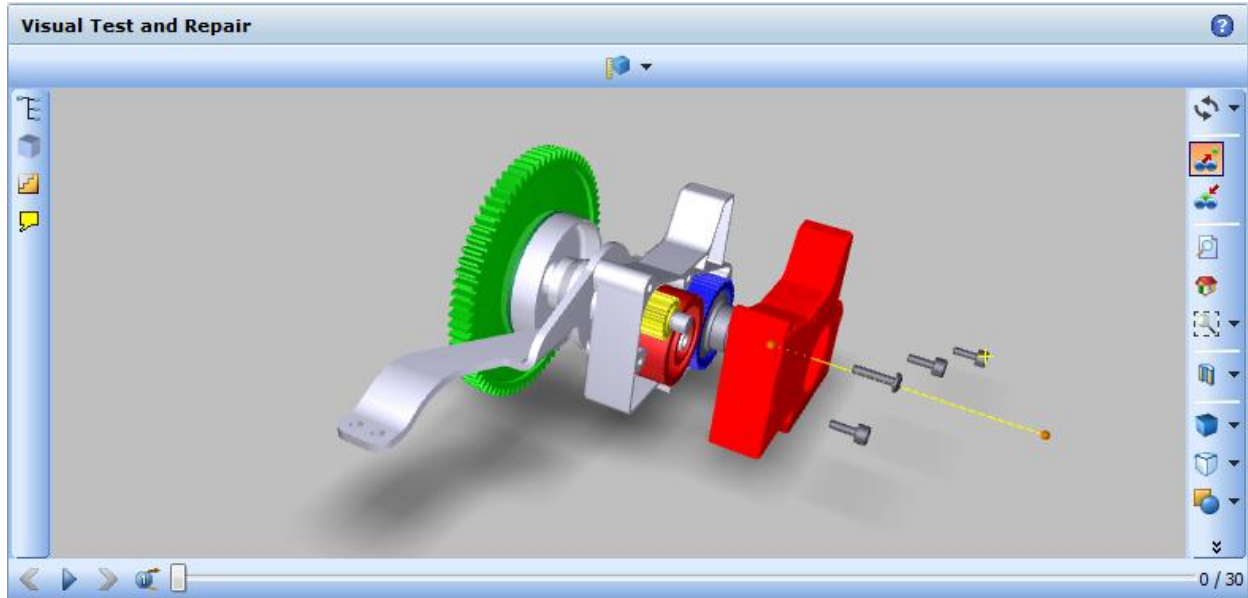

3.3.2.2.2 Reassemble

To reassemble one or more objects, select the object(s), then select the Re-assemble icon on the right hand toolbar. The selected object(s) will be moved back to their original position.

3.3.2.2.3 Cross Section

To create and manipulate cross sections of the 3D model, select the drop-down for the Cross Section icon on the right hand toolbar. For more details on cross sectioning, see *Scene Presentation Effects* in SAP ME Help. Cross sectioning is useful for providing access to interior objects (in an assembly) that are otherwise not visible for selection.

3.3.2.2.4 Model Render Mode

To change the model rendering (solid, transparent, wireframe, etc.), select the drop-down for the Model Render Mode icon on the right hand toolbar. For more details on model rendering, see *Render Modes* in SAP ME Help.

3.3.2.2.5 Projection

To change the type of projection, select the drop-down for the Projection icon on the right hand toolbar and select either Perspective Projection or Orthographic Projection. The perspective projection displays the objects as we would see them (using vanishing point), while the orthographic projection displays the objects based upon their actual physical characteristics (parallel edges, no vanishing point).

3.3.2.2.6 X-ray

To utilize the X-Ray capabilities, select the drop-down for the X-Ray icon on the right hand toolbar and select either None, Selected or Unselected.

- None – No objects will be displayed as an x-ray image
- Selected – All selected objects will be displayed as an x-ray image
- Unselected – All unselected objects will be displayed as an x-ray image

For more details on the 3D model manipulations, see *Working with the Viewer* in SAP ME Help.

3.3.2.3 Filter Scene

The Model Viewer provides a few ways to control filtering of the contents of the scene displayed in the viewport:

- Display / Hide Object (or Assembly)
- Hide Selection
- Hide Unselected
- Show All Objects

Filtering the contents of the scene can be useful in providing access to interior objects (in an assembly) that are otherwise not visible for selection.

3.3.2.3.1 Display / Hide Object

To display or hide a specific object (or assembly), select or unselect the checkbox for the object (or assembly) in the Object List in the Scene Tree on the left hand toolbar.

3.3.2.3.2 Hide Selection

To hide the currently selected object(s), click the right mouse button in the viewport and select the Hide Selection entry in the context menu.

3.3.2.3.3 Hide Unselected

To hide the currently unselected object(s), click the right mouse button in the viewport and select the Hide Unselected entry in the context menu.

3.3.2.3.4 Show All Objects

To display all objects (unhide hidden objects), click the right mouse button in the viewport and select the Show All Objects entry in the context menu.

3.4 Select NC Code

3.4.1 Description and Applicability

Selecting an NC Code, in the NC Selection plug-in, configures the NC Data Entry plug-in with the Data Fields specified for that NC Code. There is no direct integration between VTR and the NC Selection plug-in. For more information on NC Selection, see *Nonconformance (NC)*.

3.5 Select Model Element / Object

3.5.1 Description and Applicability

Selecting an element or object in the Model Viewer populates fields in the NC Data Entry plug-in (for example, Ref Des and Component), as configured for the NC Code selected in the NC Selection plug-in. Alternatively, specifying a Ref Des or Component value in the NC Data Entry plug-in field highlights the corresponding element (if there is one) in the Model Viewer.

3.5.2 Purpose / Effects

3.5.2.1 Select ECAD Element or 3D Model Object

3.5.2.1.1 Select ECAD Element

An element in the ECAD model can be selected in the Model Viewer in any of the following ways:

- Select element in viewport
- Select element in Elements List

When an ECAD element is selected, it is highlighted in the viewport and in the Elements List.

3.5.2.1.2 Select Element in Viewport

To select an element in the viewport, use the left mouse button to click (or double click) on the element. Double clicking on the element will also center and zoom the display of the element in the viewport.

3.5.2.1.3 Select Element in Elements List

To select an element in the Elements List, select the Elements List icon on the left hand toolbar; use the left mouse button to click (or double click) on the element in the Elements List. Double clicking on the element in the list will also center and zoom the display of the element in the viewport.

3.5.2.1.4 Select 3D Object

An object in the 3D model can be selected in the Model Viewer in any of the following ways:

- Select object in viewport
- Select object in 3D objects List

When a 3D object is selected, it is highlighted in the viewport and in the 3D Objects List.

3.5.2.1.5 Select Object in Viewport

To select an object in the viewport, use the left mouse button to click (or double click) on the object. Double clicking on the object will also center and zoom the display of the object in the viewport.

3.5.2.1.6 Select Object in 3D Objects List

To select an element in the 3D Objects List, select the Scene List icon on the left hand toolbar; use the left mouse button to click (or double click) on the object in the 3D Objects list. Double clicking on the object in the list will also center and zoom the display of the object in the viewport.

3.5.2.2 Specify Value in NC Data Entry Plug-in Field

When a value is specified in the NC Data Entry plug-in field that corresponds to the refdes metadata field, the corresponding ECAD element or 3D object, that has that refdes value, is highlighted in the viewport and in the Elements List or 3D Objects List.

3.5.3 Process Flow

This figure illustrates the primary flow of user and system actions when an ECAD element or a 3D object is selected. User Action is in blue and system action is in light blue.

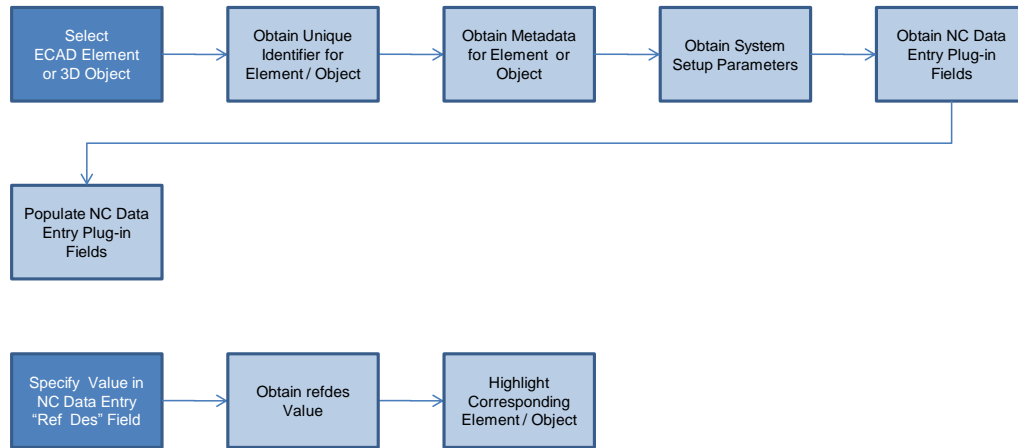

3.5.4 Data Model

The following figure shows the relationship between some of the VTR functions and ME database tables.

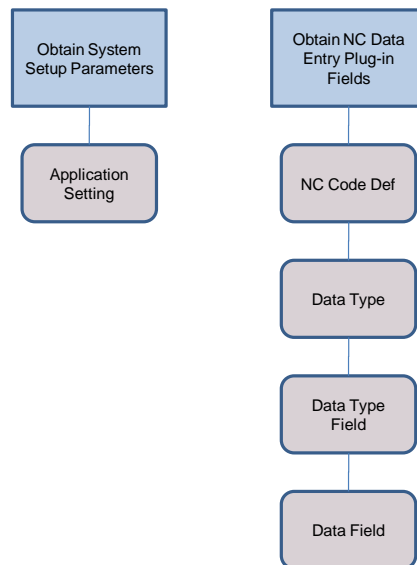

3.5.5 Function Specific Setup

This function relies on the [System Setup Properties](#).

3.6 Log NC Code

3.6.1 Description and Applicability

To log an NC Code, select the Add or the Add – Done button in the NC Data Entry plug-in. Log NC Code is a Nonconformance process that does not contain any VTR specific processing. For more information see *Nonconformance (NC)* in SAP ME Help.

3.7 Log a Test / Inspection Failure

3.7.1 Description and Applicability

Logging a Failure in VTR consists of:

- Selecting a Failure NC Code (See [Select NC Code](#))
- Selecting a Model Element (See [Select Model Element/Object](#))
- Logging an NC Code (See [Log NC Code](#))

3.8 View Element or Object for Logged NC Code

3.8.1 Description and Applicability

Selecting a logged NC Code (existing row) in the *NC Tree* highlights, centers and zooms the corresponding ECAD element or 3D object (if there is one) in the Model Viewer.

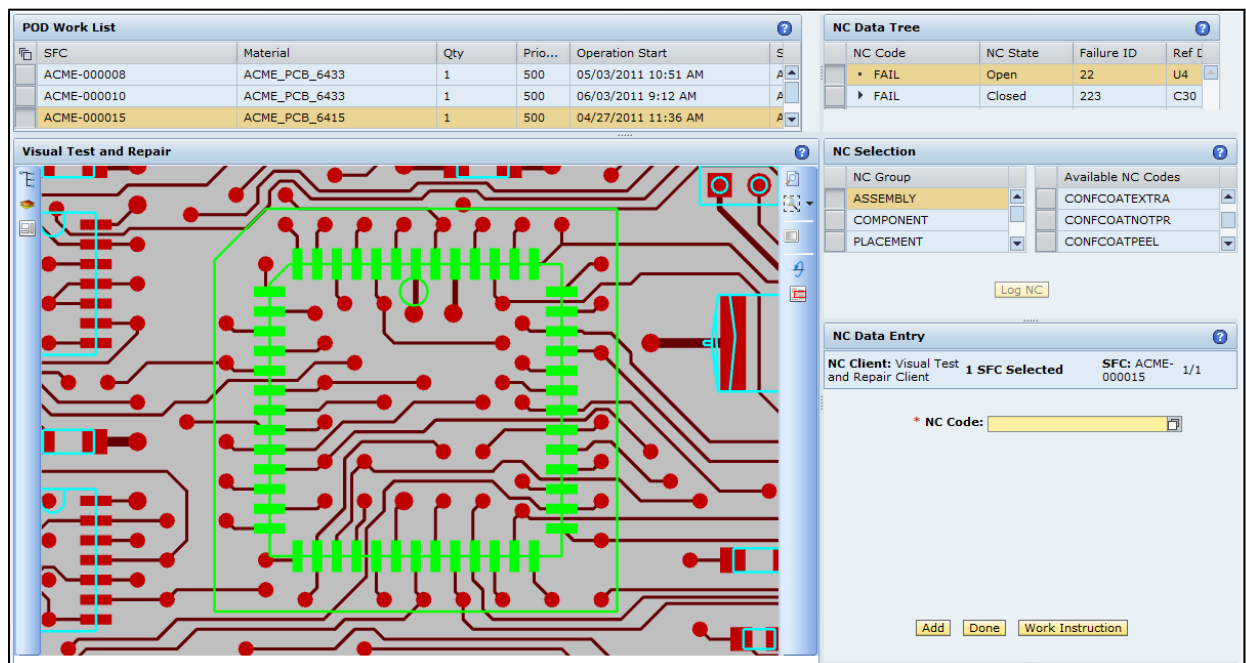

This function can be used to simply view the element or the object associated to the logged NC Code or it can be used as a starting point for performing Analysis (logging a Defect NC Code) or logging a Repair NC Code. See [Perform Analysis and Log Defect](#) or [Perform and Log Repair](#) below.

3.8.2 Process Flow

This figure illustrates the primary flow of user and system actions when an existing row in the NC Tree is selected. User Action is in blue and system action is in light blue.

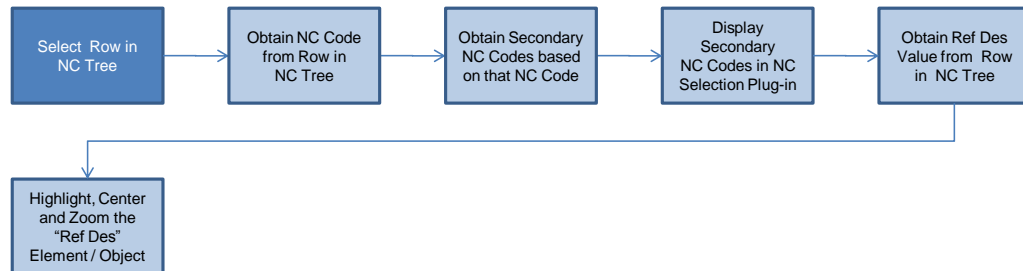

3.8.3 Data Model

The following figure shows the relationship between one of the VTR actions and related ME database tables for the Select Row in NC Tree process.

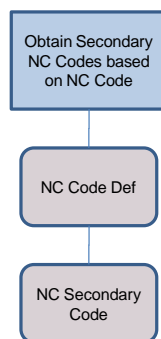

3.8.4 Best Practices

There is a problem if the component name or ref des in the model uses lower case (or some special characters). ME stores the data in upper case (and ignores certain special characters). So, when it tries to match the data from ME with the metadata from the model (for example, when you select a row in the NC Data Tree or select a ref des value or component ID from ME), the data will not match. This is being fixed in an upcoming version, so that the comparison will ignore the case of the characters. However, certain special characters in the ref des or deviceref metadata in the model will still be a problem. Make sure that only special characters supported by ME are used.

3.9 Perform Analysis and Log Defect

3.9.1 Description and Applicability

Once a Failure has been logged, the user may need to perform some analysis to determine what Defect(s) caused the failure. Especially for PCA boards, VTR can sometimes facilitate this analysis. When a defect has been identified, VTR can facilitate the logging of the Defect NC Code.

3.9.2 Purpose / Effects

3.9.2.1 Perform Analysis

The PCB Layout and the Schematic Sheets in the ECAD model can be used to guide the user in analyzing potential causes of a test failure. This could include starting from the Test Point where the failure was detected and visually following the associated Route element to the components that might be faulty.

3.9.2.2 Log Defect Code

Once the defective element and cause have been determined, the user can select the appropriate NC Code; select the ECAD model element; and log the Defect NC Code.

3.10 Perform and Log a Repair

3.10.1 Description and Applicability

Once a Failure or a Defect has been logged, VTR can be used to ensure that the appropriate element on the PCA board, or the appropriate part in an assembly, is repaired or replaced. When the appropriate repair action has been taken, VTR can facilitate the logging of the Repair NC Code.

3.10.2 Purpose / Effects

3.10.2.1 Perform Repair

VTR can facilitate the performing of the repair action. It can provide a visual indication of the defective element, or object, by highlighting it in the model.

3.10.2.2 Log Repair Code

Once the repair action has been performed, the user can select the appropriate NC Code; select the ECAD model element, if needed; and log the Repair NC Code.

4 Integration

4.1 Integration with Nonconformance

VTR provides bi-directional integration with the SAP ME Nonconformance feature. This includes:

- Fields in NC Data Entry are automatically populated when a VTR model element is selected
- The appropriate VTR model element is highlighted when the contents of specific fields in NC Data Entry are modified
- The appropriate VTR model element is highlighted, centered and zoomed when a row in the NC Tree is selected

5 VTR Setup

5.1 External Configuration

5.1.1 Installation

The VTR Model Viewer utilizes a separate Active-X component (Product Visualization) that must be installed on each client device that will be used to run VTR.

Download the latest SAP Product Visualization 7.2 installation program from SAP Service Market Place and store it in a network share directory.

There are several approaches to installing the Visual Test and Repair model viewer (Product Visualization 7.2) on each client device that will be using this feature:

- Have the user of the client device install it.
- Have the implementation team or system administrator install it on each client device.
- Set up a Group Policy to install it on each device.

In the first two cases, proceed as follows:

1. From the client device, download and execute the installation program.
2. Interact with the installer as follows:
 - a) Choose *Yes*, if prompted with a security warning.
 - b) Close all SAP applications and choose *Next*.
 - c) Select the *Product Visualization* checkbox and choose *Next*.
 - d) Specify the installation directory on the client device and choose *Next*.
 - e) Choose *Done*.

For using Windows Group Policy, see the *Microsoft Group Policy Settings Reference* document for your operating system. Reference documents are available from www.microsoft.com/downloads (search for **Group Policy Settings Reference**).

5.1.2 External Program Setup

In order for the VTR Model Viewer Active-X component to load on your client device, the Internet Explorer – Internet Options – Advanced – Security – “Allow active content in files to run on My Computer” option must be selected.

In order to view ECAD models, an ECAD Add-in Module must be licensed, installed and activated. Please see SAP Note 1590285 for information regarding obtaining and installing the ECAD Add-in Module.

5.1.2.1 Installing ECAD file converters

The following procedure will install ECAD file converters that require a license from Right Hemisphere. This procedure needs to be performed from each client device. The file converter software will be installed in the directory structure where the Model Viewer is installed.

In order to successfully complete the installation process, you will need access to the licensed ECAD file converters. Prior to using the licensed ECAD file converters, you will also need to enter a license key and code. These should be provided to you by your system administrator. You can install the licensed ECAD file converters without the license key and code and can enter them later via a context menu within the Model Viewer.

1. The Model Viewer will display a dialog when an attempt is made to view an ECAD model file that requires a licensed file converter and the file converter is not present in the correct location on the client device. Select the Module Wizard button to begin the installation process.
2. Specify the location from which the licensed ECAD file converters will be obtained. The Website field should not be used. You can also enter the license key and code at this time by replacing the “enter here” text. You can proceed without entering the license key and code, but you will have to provide them prior to viewing an ECAD model that requires a licensed ECAD file converter. Select the Next button to proceed.
3. If you did not enter the license information or entered an invalid key or code, a warning dialog is displayed. Select the Back button and enter the correct license information or select the Next button to proceed without providing license information. See Activating ECAD File Converters below for instructions on providing the license key and code at a later time.
4. A download progress screen is displayed temporarily while the file converter install file is downloaded.
5. A confirmation screen is displayed. Select the Next button to proceed with the install. Select the Cancel button to terminate the install process. The Back button is disabled at this point. Do not close this window during the install process.
6. If a security dialog appears, select the Yes button.

7. If valid license information was provided, the Installation Successful dialog will be displayed. Select the Finish button to return to the Model Viewer.
8. If valid license information was **not** provided, the Installation Partially Successful dialog will be displayed. Select the Finish button to return to the Model Viewer.
9. To make the file converters available, you will need to close all Internet Explorer windows following the completion of the installation.

5.1.2.2 Activating ECAD file converters

The following options can be used to activate licensed ECAD file converters on a client device. Obtain the license key and code from your system administrator.

5.1.2.2.1 Option 1 – System Triggered

If the licensed ECAD file converters have been installed but the license key and code have not been entered, the following procedure will enable you to provide them when you attempt to view a model file that requires a licensed ECAD file converter.

1. The Model Viewer will display the following dialog. Select the Module Activation button.
2. The Module Activation dialog will enable you to provide the license key and code.
 - a. Double click the <...> in the Serial Key column, type in the license key and press Enter
 - b. Double click the <...> in the Authorization Code column, type in the license code and press Enter

The value in the Is Key/Code Valid column will change from false to true. Select OK to finish.

3. To complete the activation of the file converters, you will need to close all Internet Explorer windows.

5.1.2.2.2 Option 2 – Context Menu

If the licensed ECAD file converters have been installed but the license key and code have not been entered, the following procedure will enable you to provide them when you are viewing a model file that **does not** require a licensed ECAD file converter.

1. Right click in an open area in the Model Viewer viewport.
2. A context menu will be displayed. Select the Module Activation... entry.
3. The Module Activation dialog will enable you to provide the license key and code.
 - a. Double click the <...> in the Serial Key column, type in the license key and press Enter

- b. Double click the <...> in the Authorization Code column, type in the license code and press Enter

The value in the Is Key/Code Valid column will change from false to true. Select OK to finish.

4. To complete the activation of the file converters, you will need to close all Internet Explorer windows.

5.1.3 Client Device

Below are the minimum and recommended requirements for the ME client devices that will be running Visual Test and Repair. **Note: 64-bit Internet Explorer is not supported.**

Supported Operating Systems

WindowsXP sp3 (32 and 64)
Vista (32 and 64)
Windows 7 (32 and 64)

Recommended Operating System

Windows 7 (32 or 64)

Minimum Hardware Configuration

Pentium 4 1Ghz processor or higher
512MB of RAM (more for large model and texture sizes)
Graphics card, with the latest drivers, capable of displaying 24-bit color.

Recommended Hardware Configuration

Pentium 4, 2Ghz processor or higher
3GB of RAM (more for large model and texture sizes)
Graphics card with the latest drivers, 128MB of RAM and support for DirectX or OpenGL.

5.2 Maintenance Activities

5.2.1 System Rules

5.2.1.1 VTR Model Location

5.2.1.1.1 Purpose / Effects

This system rule is used to specify the location of the models to be displayed by the VTR Model Viewer. It is used in conjunction with the Drawing Name from the Material to create a URL for the model file.

5.2.1.1.2 Settings / Example

The VTR Model Location is a text string that provides access to the folder containing the VTR model files. This can be a text string of the form [\\computer\foldera\folderb\](#), which specifies the computer name and path to a shared folder accessible on the network. Or it can be a text string of the form <http://computer/folder/>, if a Web Server (such as IIS or NetWeaver) is used to provide access to the model files.

Either the VTR Model Location string should end with the “\” character or the Drawing Name string should begin with the “\” character to ensure that the combined string forms a valid URL. Both upper and lower case characters can be used in the text string. If a network shared folder is used, the folder containing the models must be accessible to every user who will use VTR.

An example of a VTR Model Location string for a shared folder is:
\\USPHLVM123X\SAP\VTR\MODELS\

An example of a VTR Model Location string when using a Web Server is:
<http://usphlvm123x/models/>

5.2.2 System Setup Properties

5.2.2.1 vtr.viewer.me.fields

5.2.2.1.1 Purpose / Effects

This property specifies the ME data fields to which the metadata fields from the model will be mapped. The mapping between the ME data fields and the metadata fields is based upon matching the positions in the lists of fields for the properties. ME 6.0 supports up to two fields.

5.2.2.1.2 Settings / Example

This property value is a comma separated text string containing the names of ME Data fields (see [Data Field Definition Maintenance](#)). One of the fields must be the Ref_Des field. It must be mapped to the metadata field that contains the unique identifier for the model element.

The ME data fields must be assigned to an ME data type whose category is NC (see [Data Field Assignment Maintenance](#)). The ME data type is then assigned to one or more NC Codes (see [NC Code Maintenance](#)). When the NC Code is selected in the NC Selection plug-in, the data fields are displayed in the NC Data Entry plug-in.

An example of a vtr.viewer.me.fields string is: Ref_Des,Component

5.2.2.2 vtr.viewer.vendor.fields

5.2.2.2.1 Purpose / Effects

This property specifies the model metadata fields which will be mapped to ME data fields. The mapping between the model metadata fields and the ME data fields is based upon matching the positions in the lists of fields for the properties. ME 6.0 supports up to two fields. For ECAD files, the metadata field that contains the unique identifier for the model element is refdes. The metadata field that contains the component ID is deviceref.

5.2.2.2.2 Settings / Example

This property value is a comma separated text string containing the names of model metadata fields. One of the fields must be the unique identifier for the model element. It must be mapped to the ME Ref_Des data field.

An example of a vtr.viewer.vendor.fields string is: refdes,deviceref

5.2.3 Best Practice

If a customer is going to be using VTR for both ECAD models and 3D models for the same site, the 3D models should be set up to also use the refdes and deviceref metadata fields. For 3D models, the SAP products, Visual Enterprise Author and Visual Enterprise Generator, can be used to create metadata fields and assign them values, for each object in the model.

5.2.4 Product Configuration

5.2.4.1 Material Maintenance

5.2.4.1.1 Purpose / Effects

The Drawing Name field on the Main tab in Material Maintenance is used to specify the file name for the ECAD or 3D object model for the material. It is used in conjunction with the VTR Model Location system rule to create a URL for the model file.

5.2.4.1.2 Settings / Example

The Drawing Name is a text string, typically of the form [modelname.ext](#), that specifies the filename and extension of the model file. The Drawing Name can also contain part of the path to the folder where the model is stored. This is useful for situations where models are stored in different folders.

Either the VTR Model Location string should end with the “\” character or the Drawing Name string should begin with the “\” character to ensure that the combined string forms a valid URL. Both upper and lower case characters and spaces can be used in the text string. The folder containing the models must be accessible to every user who will use VTR.

Examples of Drawing Name strings are:

GRDemo.gcm

3D_MODELS\Main Gear.rh

5.2.5 System Configuration

5.2.5.1 Data Field Definition Maintenance

5.2.5.1.1 Purpose / Effects

The data fields that are specified in the system settings property vtr.viewer.me.fields, must already be defined in Data Field Definition Maintenance.

5.2.5.1.2 Settings / Example

The Ref_Des and Component data fields are among the fields that are predefined. If a new data field is needed, fill in at least the following data entry fields on the main tab:

- Data Field Name of the data field
- Type Select Text in the drop-down

Save the data field.

5.2.5.2 Data Field Assignment Maintenance

5.2.5.2.1 Purpose / Effects

For the data fields to be utilized in VTR, they must be assigned to an NC data type in Data Field Assignment Maintenance.

5.2.5.2.2 Settings / Example

Data types using the data fields Ref_Des and Component are included in the NC data types that are predefined. If a new data type is needed, fill in at least the following data type fields on the main tab:

- Category NC
- Type Enter the name of the data type

Use the Insert xxx action links to add the needed data fields to the data type and save the data type.

5.2.5.3 POD Maintenance

5.2.5.3.1 Purpose / Effects

A POD with at least the following plug-ins is needed in order to utilize VTR:

- Model Viewer
- NC Selection
- NC Data Entry

In order to log Defects or Repairs, the NC Tree plug-in is also needed.

5.2.5.3.2 Settings / Example

A default VTR POD is predefined in ME. It uses the 3 panel horizontal layout. This may not be optimal for viewing your models. If you need to set up a new VTR POD, POD Maintenance provides a lot of flexibility in configuring a POD. See the following Best Practices and *POD Maintenance* in ME Help.

5.2.5.3.3 Best Practice

At a minimum, the default VTR POD should be used to create a new VTR POD where the Model Viewer button has the Model Viewer plug-in listed last. This will cause the model viewer to be loaded last and will avoid the issue of the VTR model being loaded and displayed three times (once for each plug-in that gets loaded) instead of just once.

SAP ME How-To-Guide for Visual Test and Repair (VTR)

An operation POD definition that has proven effective for viewing several types of models is described in the following tables. It may be a good starting point for a more usable VTR POD. It uses the 6 panel vertical layout and pre-loads the Model Viewer plug-in and the NC plug-ins.

Buttons Table - This table represents the data on the Buttons tab.

Button Label	Button Type	Activity
I18N[start.default.BUTTON]	Normal	PR500
I18N[complete.default.BUTTON]	Normal	PR510
I18N[signoff.default.BUTTON]	Normal	PR520
I18N[workinstructions.default.BUTTON]	Normal	WI_LIST_DISPLAY
I18N[activities.default.BUTTON]	Group	See Activities Table
I18N[reports.default.BUTTON]	Group	See Reports Table

Activities Table – These activities are included under the Activities button:

Activity ID	Description
CT510	As-Built Configuration
GHG_EQUIP_STATUS	Change Equipment Status
PR555	Collect Parent Serial Number
CREATE_MESS_PLUGIN	Create Message
LOG_COMMENT	Log Comment
PR550	Serialize
SFC_DATA_ENTRY	SFC Data Entry
SU520	SFC Place Hold
SU530	SFC Release Hold
DC550	Data Collection Standalone

Reports Table – These reports are included under the Reports button:

Activity ID	Report Name
TR700	Activity Log Report
CT700	As-Built Summary Report
BUYOFF_REPORT	Buyoff Report
DM710	Comment Report
SU750	Hold Report
NC700	NC Log Report
DM700	SFC Report
DM730	Shop Order Report

Layout Table – This table represents the data on the Layouts tab:

Panel	Type	Default Plug-in	Other Plug-ins
A	Fixed	WORKLIST_DISPLAY	
B	Fixed	NC_TREE	
C	Fixed	MODEL_VIEWER	
D	Fixed	NC_SELECTION	
E	Fixed	NC_DATA_ENTRY	
F	Fixed		
	Pop-up		All above activities and reports

5.2.6 Other Maintenance Activities

5.2.6.1 NC Code Maintenance

5.2.6.1.1 Purpose / Effects

Each NC Code must have an associated ME Data Type. The data type identifies the data entry fields to be displayed in the NC Data Entry plug-in for the NC Code. If you need to define a new NC Code, see *NC Code Maintenance* in ME Help.

5.2.6.1.2 Settings / Example

To specify the ME Data Type for an NC Code, retrieve the NC Code in NC Code Maintenance and select the desired data type in the Data Type drop-down on the main tab.

5.2.6.1.3 Data Flow

The following figure shows the high level flow for the setup of VTR. Unlinked items can be done in any sequence.

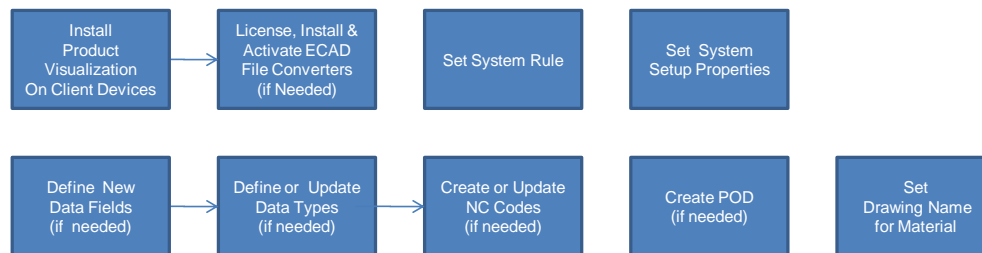

6 Usage Scenario Examples

6.1 ECAD Test Failure, Analysis and Repair Scenario

6.1.1 Purpose / Goal

This scenario provides an example where there is a test failure for a PCA board. As a result, the failure must be analyzed and the cause logged as a defect. The appropriate disposition for the defect must then be determined and logged.

For this scenario the following preconditions apply:

- Material ACME_PCB_3451 is a PCA board with an associated ECAD model (GRDemo.gcm)
- The ECAD model contains components, routes and test points
- Operation PCB_TEST_ANALYZE_REPAIR is being performed at resource PCB_STATION
- A PCA board with SFC number ACME-3451-000004 is to be processed at this operation

6.1.2 Scenario Specific Settings

In order to log all three types of NC Codes, the NC Client specified for the VTR POD, must allow the logging of both Primary and Secondary NC Codes. To ensure this, select both of the following checkboxes on the main tab in NC Client Maintenance:

- Can Log Primary NC Code
- Can Log Secondary NC Code

6.1.3 Scenario Steps

The following are examples of the steps that a user might perform in SAP ME in order to accomplish this scenario.

6.1.3.1 Log Test Failure

1. Open the default VTR POD (POD – Visual Test and Repair)
2. Select operation PCB_TEST_ANALYZE_REPAIR
3. Select resource PCB_STATION
4. Select the browse for SFC numbers
5. Select SFC number ACME-3451-000004
6. Select the Start button to process ACME-3451-000004
7. External event – test P358 fails at the bottom left test point with failure code F1-22
8. Select the FAIL NC code in NC Selection (displays fields in NC Data Entry)
9. Enter “Test P358 failed with failure code F1-22” in the Comments text box in the NC Data Entry plug-in
10. Select the Flip Board icon on the right hand toolbar in the Model Viewer (test points are on the bottom of the board)
11. Pan and zoom the image in the viewport to clearly show the bottom left test point
12. Double click on the bottom left test point (highlights, centers and zooms the test point in the viewport and puts 203, the refdes value from the test point, in the Ref Des field in the NC Data Entry plug-in)
13. Select the Add button in the NC Data Entry plug-in (logs the FAIL NC code and deselects the test point in the viewport)

6.1.3.2 Analyze and Log Defect

14. Select the NC Tree button in the POD (displays the NC tree in a pop-up window)
15. Select the row in the NC Tree and select the Return to POD button (highlights, centers and zooms test point 203 and displays the secondary NC code groups and codes in NC Selection)
16. Double click on the route connected to test point 203 in the viewport (highlights, centers and zooms the selected route, which shows multiple segments)
17. Visually follow the route (UN168HC1190PMODB) to the first component (WT5)
18. External event – examination and test of component WT5 finds no defect
19. Flip the board by selecting the Flip board icon on the right hand toolbar (next segment of the route is on the top of the board)
20. Pan the image in the viewport to find the next segment of the route (alternatively, you could select the Elements icon on the left hand toolbar; double click on component WT5 in the elements list; and then double click on the route connected to that component)

SAP ME How-To-Guide for Visual Test and Repair (VTR)

21. Visually follow the route (UN168HC1190PMODB) to the next component (C1)
22. External event – examination and test of component C1 finds that the component has a bent lead that is not making contact
23. Select the COMPONENT NC group and the LEAD-BENT NC code in NC Data Entry
24. Select component C1 in the viewport (highlights component C1 in the viewport and puts C1 in the Ref Des field and 4399-3047-00 in the Component field in NC Data Entry)
25. Select the Add button in the NC Data Entry plug-in (logs the LEAD-BENT NC code and deselects component C1 in the viewport)

6.1.3.3 Log Repair

26. External event – component C1 is removed, repaired and reinstalled on the board
27. Select the NC Tree button in the POD (displays the NC tree in a pop-up window)
28. Select the row in the NC Tree with the LEAD-BENT NC code and select the Return to POD button (highlights, centers and zooms component C1 and displays the REPAIRACTION NC code group and codes in NC Selection)
29. Select the DONE NC code in NC Selection (displays DONE in the NC Code field in NC Data Entry)
30. Select the Add button in NC Data Entry (logs the DONE NC code, deselects component C1 in the viewport and changes the NC state of the logged FAIL, LEAD-BENT and DONE NC Codes to Closed)

6.1.4 Scenario Flow

The following figure provides a high level flow of the VTR Test, Analysis and Repair scenario.

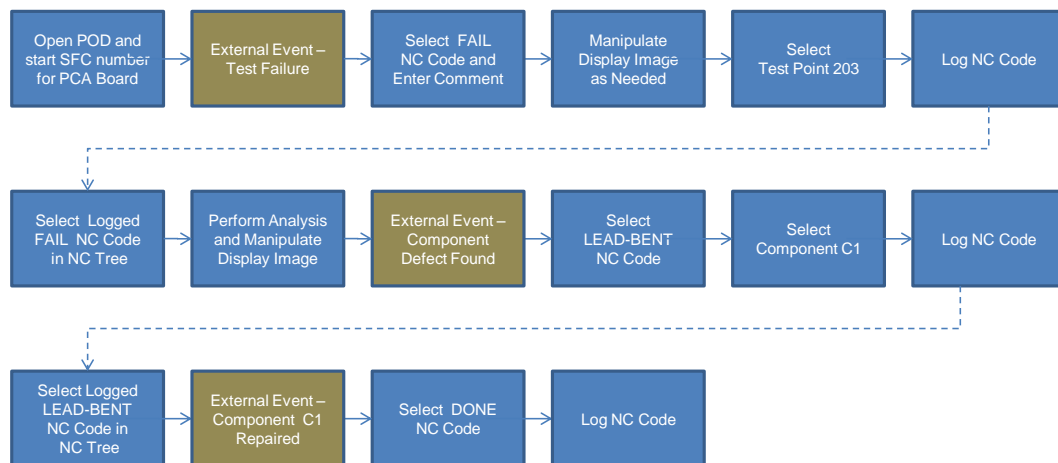

6.1.5 Scenario Best Practices

Adding a comment field to the data type for the DONE NC code would enable the user to enter a comment regarding the specifics of the repair or the condition of the component.

7 Links to Additional Information

- [Visual Test and Repair \(VTR\) POD](#) – Link to VTR POD information in SAP ME Help
- [Visual Test and Repair](#) – Link to VTR information in SAP ME Help
- [Visual Test and Repair](#) – Link to VTR information in SAP Solution Manager
- [Configuring Visual Test and Repair](#) – Link to VTR configuration information in SAP Solution Manager

8 Other Reference Material

Not Applicable

9 Overview of Changes

9.1 PCA Dashboard Replaced by Visual Test and Repair

The PCA Dashboard (PCAD), available in earlier versions of SAP ME has been replaced by Visual Test and Repair (VTR). Here are some of the benefits of VTR over PCAD:

- VTR uses a different viewer, that runs on the client device, and therefore supports an unlimited number of users simultaneously
- VTR supports both ECAD models and 3D solid models
- The VTR viewer is now an SAP product, ensuring on-going support
- VTR is a complete replacement for PCAD (i.e. it provides effectively all of the functionality that was in PCAD)